

FX 防音可変側溝

新技術情報システム (NETIS) 登録番号:KT-010223

騒音公害解消

FX防音可変側溝は、騒音公害を新しい理論による独特の形状を採用することで解消しました。そして、フィット性／経済性／機能性／強度／施工性／維持管理等のメリットを生み出しました。

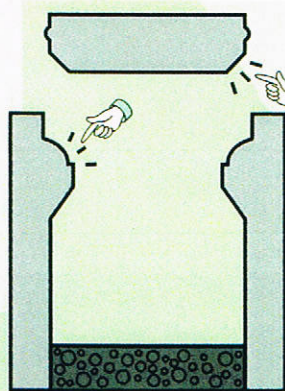

このカタチがユニバーサルデザイン!!

3つのSをお約束します！

強い(strong)・安全(safety)・静寂(silent)

- 車両荷重種別T-25(5tf)に対応しています。(strong)
- 側面に出っ張りが無く、十分な転圧が可能です。(safety)
- 線接触で騒音問題を解消します。(silent)

信頼の実績

販売開始より **10万m[100km]** 達成！

このカタチがユニバーサルデザインです

FX防音可変側溝

騒音問題を解消。

しかもリーズナブル

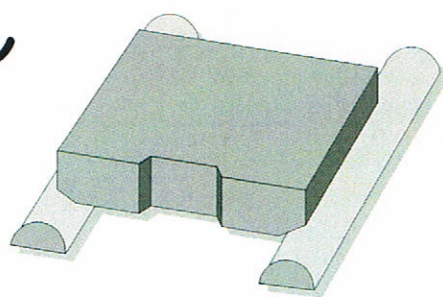
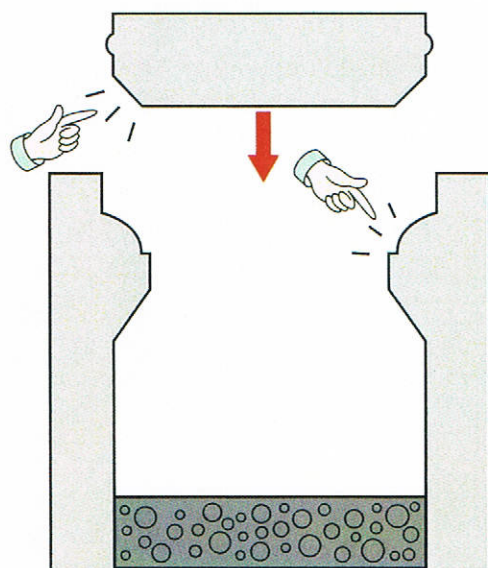

FX可変側溝は、従来型では避けられなかった騒音公害を、新しい理論による独特の形状を採用することで解消するとともに、以下のような、さまざまなメリットをも生みだしました。

FX防音可変側溝の特長

- **ピタリフィット** : 蓋と側溝が、R面とV面で線接触し消音用ゴムを使わずに騒音をシャットアウト
- **経済性** : 従来の側面張出しタイプより製品幅が小さく重量も軽い。
: 掘削量が小さく、廃土が少ない。
: 宅地造成では、宅地有効率が上がる。
- **機能性** : 巾が小さくコンパクトなので、道路舗装面を広くとれ有効利用できる。したがって狭い道路に効果的。
- **強度** : 車両荷重種別 T-25 (5tf) 対応製品。
- **施工性** : 側面がフラットなので転圧が容易。
: 既設の構築物にピタリ合わせてセットできる。
: 内吊りが簡単にできるので水系を触れずに据え付けできる。
- **維持管理** : 蓋が軽いのであげ易く、側溝の掃除が楽にできる。
(例…300蓋従来型41kg FX型31kg)

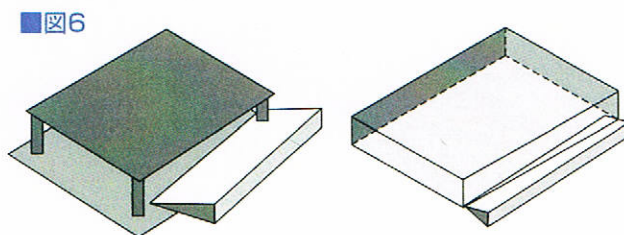
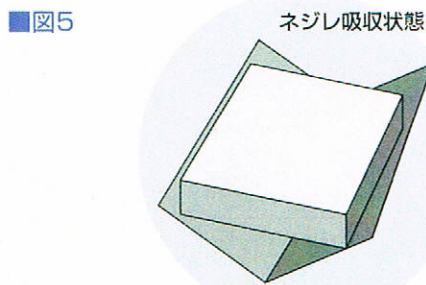
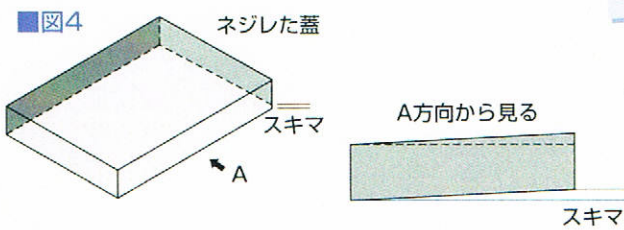

4本脚のうち1本だけ短いとき、スキマにクサビを入れるのと同じ原理。

画期的な “線接触”セオリー

騒音の原因である“ネジレ・曲がり”をいかにして克服するか？
製品の完全な平面化が技術的に困難である以上、それを吸収するよい方法はないか？
こうして研究を重ねた結果が、以下に述べる「RV理論」なのです。

ネジレ、曲がりの吸収

コロンブスの卵的発想で開発されたのが“線接触”の理論。

図5のように、蓋を“水平面”で受けるのではなく、“斜面”を設置することで“線”で受ける。こうして、不安定な“点接触”をさけることができます。

これは図6のように、4本足の1本が短い場合に、クサビを入れてスキマをなくすのと同じ原理なのです。

優れた安定性

このように、RV理論は、V面でネジレを吸収し、R面との線接触を図ることで、蓋と側溝の接点を最低限4点確保。

スキマがなく、騒音が発生しない施工を可能としました。

ここが改良されました (ここを改良しました)

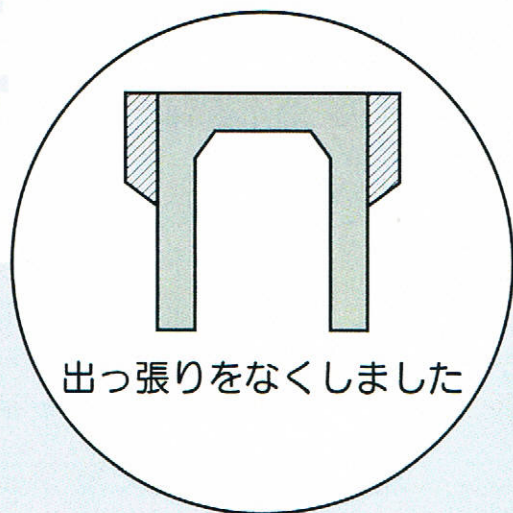

十分な転圧ができる

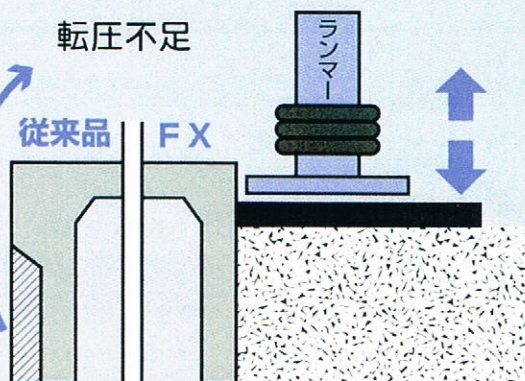

車道用T-25対応

FX防音可変側溝

300~600

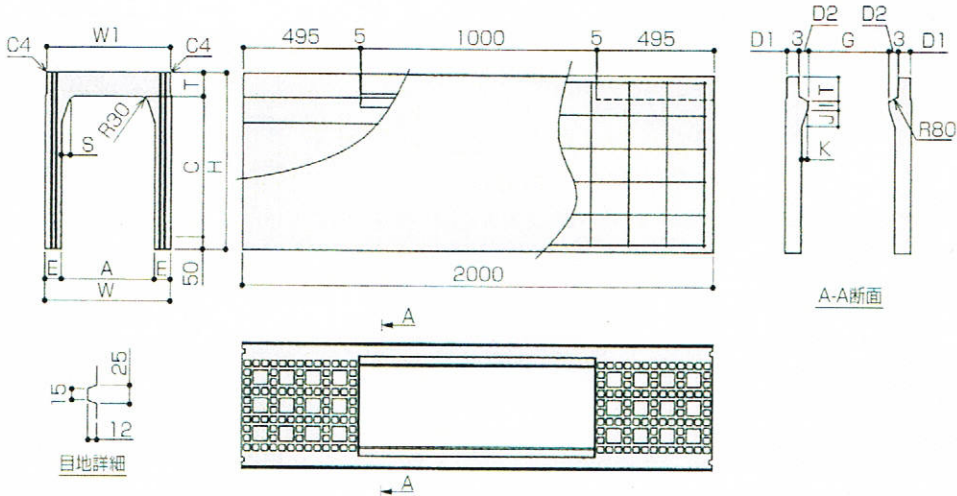
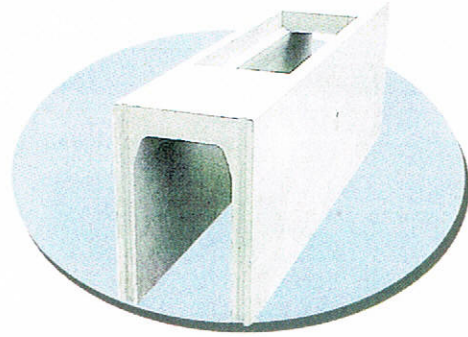

■規格表

呼び名 (幅×深)	寸 法 (mm)														参考質量 (kg)
	A	C	W	W1	H	T	D1	D2	E	G	I	J	K	S	
300×300		298			435										315
400		398	420		535				60						371
500		498			635										428
600		598			735										514
700	300	698	430		835	87	45	35	65	254	30	65	23	29	575
800		798		420	935				75						714
900		898	450		1035										784
1000		998			1135										948
1100		1098	470		1235				85						1029
1200		1198			1335										1107
400×400		398			550										447
500		498	530		650				65						508
600		598			750										569
700		698			850				70						665
800	400	798	540		950	102	50	40	80	344	40	70	28	39	730
900		898	560	530	1050										884
1000		998			1150										959
1100		1098			1250										1139
1200		1198	580		1350				90						1223
1300		1298			1450										
500×400		398			565										549
500		498			665										619
600		598	650		765				75						690
700		698			865										760
800		798			965										831
900		898			1065										991
1000	500	998	670	650	1165	117	55	45	85	444	40	70	28	39	1071
1100		1098			1265										1146
1200		1198			1365										1346
1300		1298			1465										1436
1400		1398	690		1565				95						1525
1500		1498			1665										1614
600×400		398			580										628
500		498			680										703
600		598	760		780				80						778
700		698			880										854
800		798			980										929
900		898			1080										1004
1000	600	998	760	760	1180	132	55	50	90	544	40	70	28	39	1187
1100		1098			1280										1264
1200		1198			1380										1349
1300		1298			1480										1561
1400		1398			1580										1655
1500		1498	800		1680				100						1749
1600		1598			1780										1843

車道用T-25対応

FX防音可変側溝

700~1,000

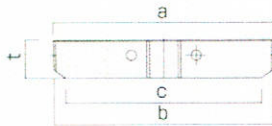
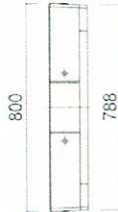
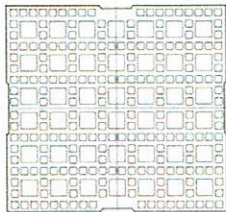
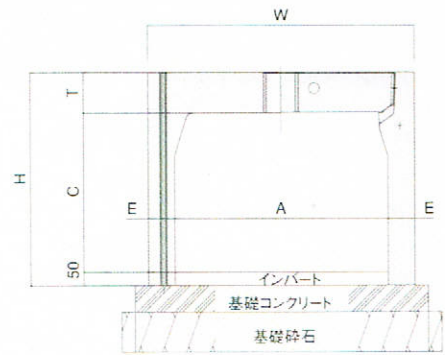
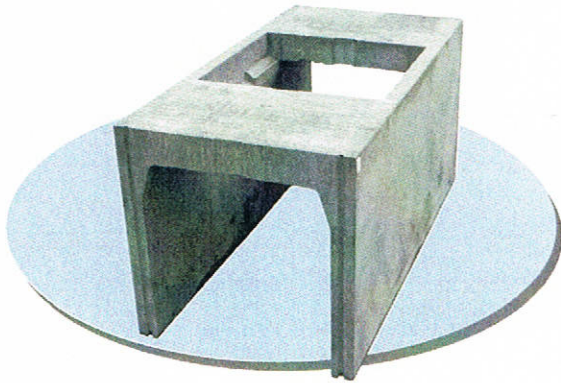

呼び名 (幅×深)	寸 法 (mm)					参考質量 (kg)
	a	b	c	t	t1	
700	752	744	669	140	1132	190
800	852	844	755	150	1182	231
900	952	944	855	160	1283	277
1000	1052	1044	955	170	1383	328

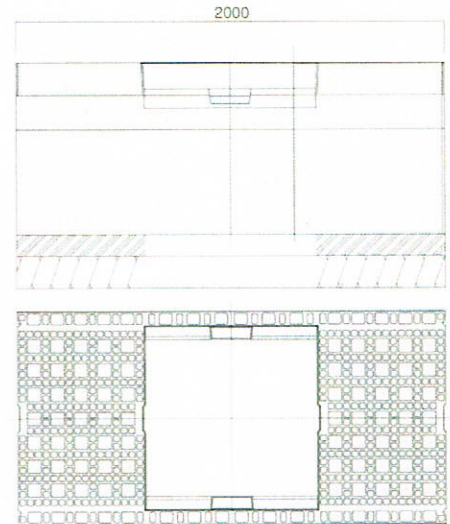

蓋1枚使用

■規格表

呼び名 (幅×深)	寸 法 (mm)															参考質量 (kg)
	A	C	W	W ₁	H	T	D ₁	D ₂	E	G	I	J	K	S		
700× 500		498			690											943
600		598			790											1036
700		698			890											1130
800		798			990											1223
900		898			1090											1317
1000	700	998	900	900	1190	142	70	60	100	642	60	100	34	49	1411	
1100		1098			1290											1504
1200		1198			1390											1598
1300		1298			1490											1691
1400		1398			1590											1785
1500		1498			1690											1879
800× 600		598			800											1107
700		698			900											1200
800		798			1000											1294
900		898			1100											1387
1000	800	998	1000	1000	1200	152	70	60	100	732	60	100	34	49	1481	
1100		1098			1300											1575
1200		1198			1400											1668
1300		1298			1500											1762
1400		1398			1600											1855
1500		1498			1700											1949
900× 700		698			910											1277
800		798			1010											1370
900		898			1110											1464
1000	900	998	1100	1100	1210	162	70	60	100	832	60	100	34	49	1557	
1100		1098			1310											1651
1200		1198			1410											1745
1300		1298			1510											1838
1400		1398			1610											1932
1500		1498			1710											2025
1000× 800		798			1020											1452
900		898			1120											1545
1000	1000	998	1200	1200	1220	172	70	60	100	932	60	100	34	49	1639	
1100		1098			1320											1732
1200		1198			1420											1826
1300		1298			1520											1920
1400		1398			1620											2013
1500		1498			1720											2107

FX防音可変側溝 車道用T-25対応

横断用(鋼板卷)

300~600

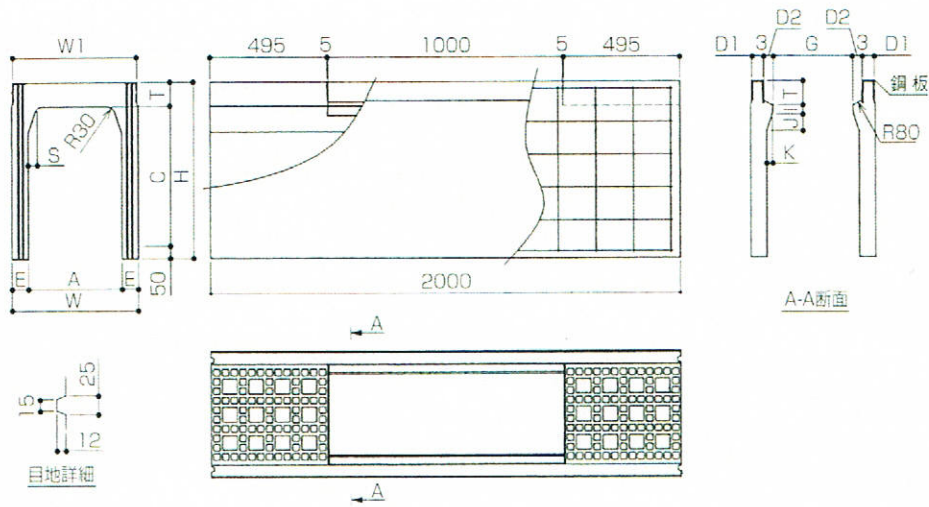
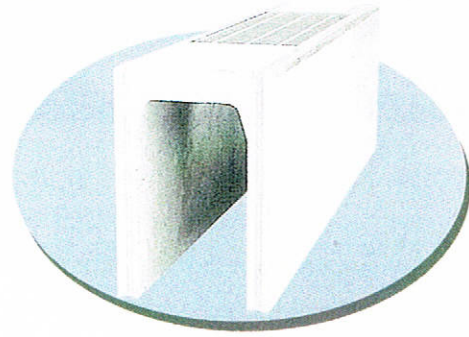

■規格表

呼び名 (幅×深)	寸 法 (mm)													参考質量 (kg)			
	A	C	W	W1	H	T	D ₁	D ₂	E	G	I	J	K		S		
300× 300		298			435											315	
400		398	420		535				60							371	
500		498			635											428	
600		598	430		735											514	
700	300	698			835											575	
800			798	420		935	87	45	35		254	30	65	21	29	714	
900			898	450		1035											784
1000			998			1135											948
1100			1098	470		1235											1029
1200			1198			1335											1107
400× 400			398			550											447
500			498	530		650				65							508
600			598			750											569
700			698	540		850											665
800		400	798	530	530	950	102	50	40	70	344	40	70	26	39		730
900				898			1050										
1000			998	560		1150				80							959
1100			1098	580		1250				90							1139
1200			1198			1350											1223
500× 500			498			665											619
600		598	650		765				75							690	
700		698			865											760	
800		798			965											831	
900	500	898			1065											991	
1000			998	650	650	1165	117	55	45	85	444	40	70	26	39	1071	
1100			1098			1265											1146
1200			1198			1365											1346
1300			1298	690		1465				95							1436
1400			1398			1565											1525
600× 500		498			630											703	
600		598			730											778	
700		698	760		830				80							854	
800		798			930											929	
900		898			1030											1004	
1000	600	998			1130											1187	
1100			1098	760	760	1180	132	55	50		544	40	70	26	39	1187	
1200			1198			1280				90							1264
1300			1298			1380											1349
1400			1398	800		1480											1561
1500			1498			1580				100							1655
					1680											1749	

FX防音可変側溝 車道用T-25対応

横断用(鋼板卷)

700~1,000

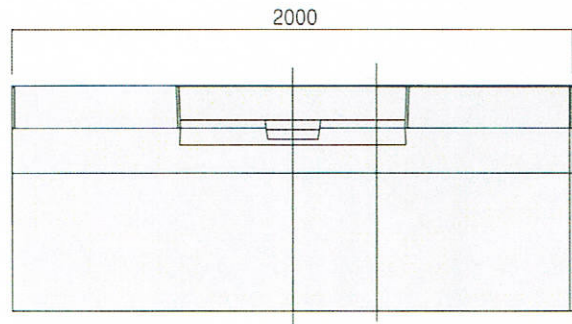
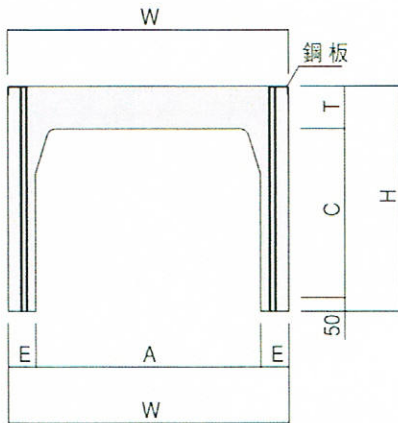

■規格表

呼び名 (幅×深)	寸 法 (mm)														参考質量 (kg)	
	A	C	W	W ₁	H	T	D ₁	D ₂	E	G	I	J	K	S		
700× 500		498			690											943
600		598			790											1036
700		698			890											1130
800		798			990											1223
900		898			1090											1317
1000	700	998	900	900	1190	142	70	60	100	642	60	100	34	49	1411	
1100		1098			1290											1504
1200		1198			1390											1598
1300		1298			1490											1691
1400		1398			1590											1785
1500		1498			1690											1879
800× 600		598			800											1107
700		698			900											1200
800		798			1000											1294
900		898			1100											1387
1000	800	998	1000	1000	1200	152	70	60	100	732	60	100	34	49	1481	
1100		1098			1300											1575
1200		1198			1400											1688
1300		1298			1500											1762
1400		1398			1600											1855
1500		1498			1700											1949
900× 700		698			910											1277
800		798			1010											1370
900		898			1110											1464
1000		998			1210											1557
1100	900	1098	1100	1100	1310	162	70	60	100	832	60	100	34	49	1651	
1200		1198			1410											1745
1300		1298			1510											1838
1400		1398			1610											1932
1500		1498			1710											2025
1000× 800		798			1020											1452
900		898			1120											1545
1000		998			1220											1639
1100	1000	1098	1200	1200	1320	172	70	60	100	932	60	100	34	49	1732	
1200		1198			1420											1826
1300		1298			1520											1920
1400		1398			1620											2013
1500		1498			1720											2107

FX防音可変側溝 車道用T-25対応

90° コーナー

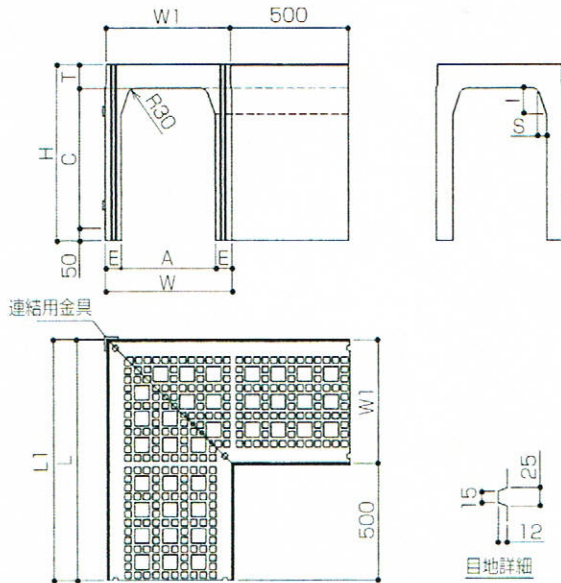
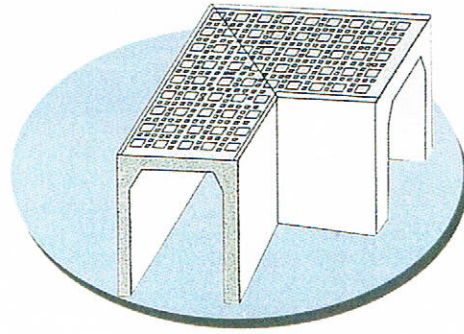

■規格表

呼び名 (幅×深)	寸 法 (mm)											参考質量 (kg)	
	A	C	W	W ₁	H	T	E	I	S	L	L ₁		
300× 300		298			435								134
400		398	420		535		60				920		154
500		498			635								174
600		598	430		735		65						204
700	300	698			835	87		95	29	920			226
800		798	450	420	935		75						275
900		898			1035								300
1000		998			1135								358
1100		1098	470		1235		85						386
1200		1198			1335								414
400× 400		398			550								208
500		498	530		650		65				1030		232
600		598			750								255
700		698	540		850		70	110	39	1030			291
800	400	798		530	950	102							316
900		898	560		1050		80						375
1000		998			1150								404
1100		1098	580		1250		90						473
1200		1198			1350								505
500× 500		498			665								314
600		598	650		765		75						342
700		698			865								371
800		798			965								400
900		898	670	650	1065	117		110	39	1150			467
1000	500	998			1165		85						499
1100		1098			1265								532
1200		1198	690		1365								613
1300		1298			1465		95						650
1400		1398			1565								686
600× 500		498			680								396
600		598	760		780		80						429
700		698			880								462
800		798			980								495
900		898	760	760	1080	132		110	39	1260			528
1000	600	998			1180								605
1100		1098	780		1280		90						642
1200		1198			1380								679
1300		1298			1480								773
1400		1398	800		1580		100						814
1500		1498			1680								855

※1コーナーで2個使用します。※参考重量は、1個あたりの重量です。

FX防音可変側溝 車道用T-25対応

45° コーナー

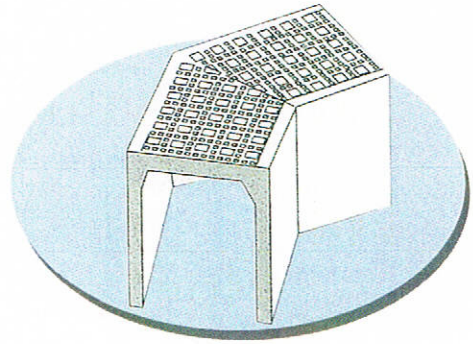
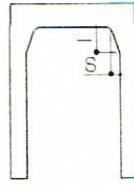
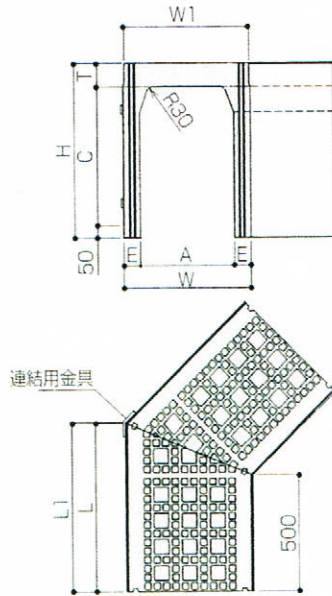

■規格表

呼び名 (幅×深)	寸 法 (mm)											参考質量 (kg)	
	A	C	W	W1	H	T	E	I	S	L	L1		
300× 300		298			435								230
400		398			535								266
500		498	430		635		65				676		302
600		598			735								338
700		698			835								372
800	300	798		420	935	87		95	29	674			498
900		898			1035								546
1000		998	470		1135		85				684.3		592
1100		1098			1235								638
1200		1198			1335								684
400× 400		398			550								344
500		498			650								384
600		598	540		750		70				721.6		424
700		698			850								464
800	400	798		530	950	102		110	39	719.5			504
900		898			1050								648
1000		998			1150								700
1100		1098	580		1250		90				729.9		752
1200		1198			1350								804
500× 500		498			665								514
600		598			765								564
700		698			865								614
800		798	670		965		85				773.4		666
900		898			1065								716
1000	500	998		650	1165	117		110	39	769.2			766
1100		1098			1265								818
1200		1198			1365								942
1300		1298	690		1465		95				777.5		998
1400		1398			1565								1054
600× 600		598			780								680
700		698			880								736
800		798			980								790
900		898	780		1080		90				818.9		846
1000		998			1180								902
1100	600	1098		760	1280	132		110	39	814.8			958
1200		1198			1380								1014
1300		1298			1480								1152
1400		1398			1580								1214
1500		1498	800		1680		100				823.1		1276
1600		1598			1780								1338

FX防音可変土留側溝 車道用T-25対応

FXウォール 300~600シリーズ

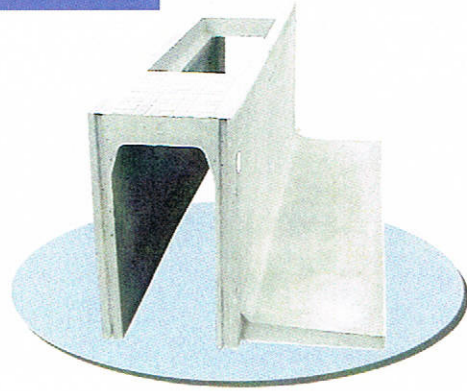
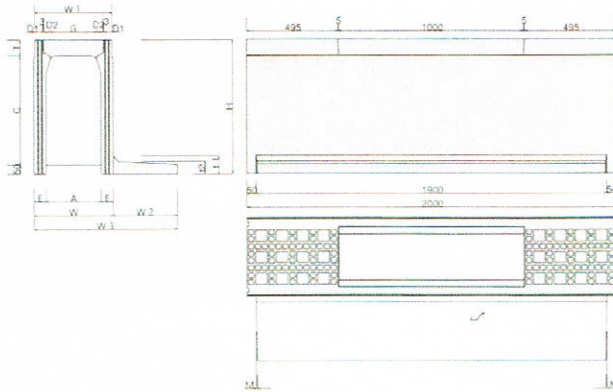

■規格表

呼び名 (幅×深)	寸法 (mm)															参考重量 (kg)	
	A	C	W	W1	W2	W3	H	T	t1	t2	D1	D2	E	G	M		
300× 300		298					435									7	412
400		398	420		350	770	535						60			8	468
500		498			400	820	635		100	70						9	534
600		598	430		450	880	735						65			10	634
700	300	698		420	500	930	835	87			45	35		254		11	703
800		798	450		550	1000	935						75			12	878
900		898			600	1050	1035									13	961
1000		998			650	1120	1135		125	85						14	1143
1100		1098	470		650	1120	1235						85			13	1224
1200		1198			700	1170	1335									14	1310
400× 400		398			350	880	550									7	544
500		498	530		400	930	650						65			8	614
600		598			450	980	750		100	70						9	689
700		698	540		500	1040	850						70			10	793
800	400	798		530	550	1090	940	102			50	40		344		11	894
900		898	560		600	1160	1050						80			12	1061
1000		998				1210	1150									13	1154
1100		1098			650	1230	1250		125	85						13	1334
1200		1198	580		700	1280	1350						90			14	1426
1300		1298				1280	1450									15	1556
500× 400		398			350	1000	565									7	646
500		498			400	1050	665									8	725
600		598	650		450	1100	765		100	70			75			9	810
700		698			500	1150	865									10	898
800		798			550	1200	965									11	995
900	500	898		650	600	1270	1065	117			55	45		444		12	1168
1000		998	670		650	1320	1165						85			13	1266
1100		1098			650	1320	1265									13	1341
1200		1198			700	1390	1365		125	85						14	1549
1300		1298			750	1440	1465									15	1684
1400		1398	690		800	1490	1565						95			16	1786
1500		1498			850	1540	1665									17	1883
600× 400		398			350	1110	580									7	725
500		498			400	1160	680									8	809
600		598	760		450	1210	780									9	898
700		698			500	1260	880		100	70			80			10	982
800		798			550	1310	980									11	1093
900	600	898		760	600	1360	1080	132			55	50		544		12	1181
1000		998			650	1430	1180						90			13	1382
1100		1098	780		700	1480	1280									13	1459
1200		1198			700	1480	1380									14	1552
1300		1298			750	1550	1480		125	85						15	1809
1400		1398	800		800	1600	1580						100			16	1916
1500		1498			850	1650	1680									17	2018

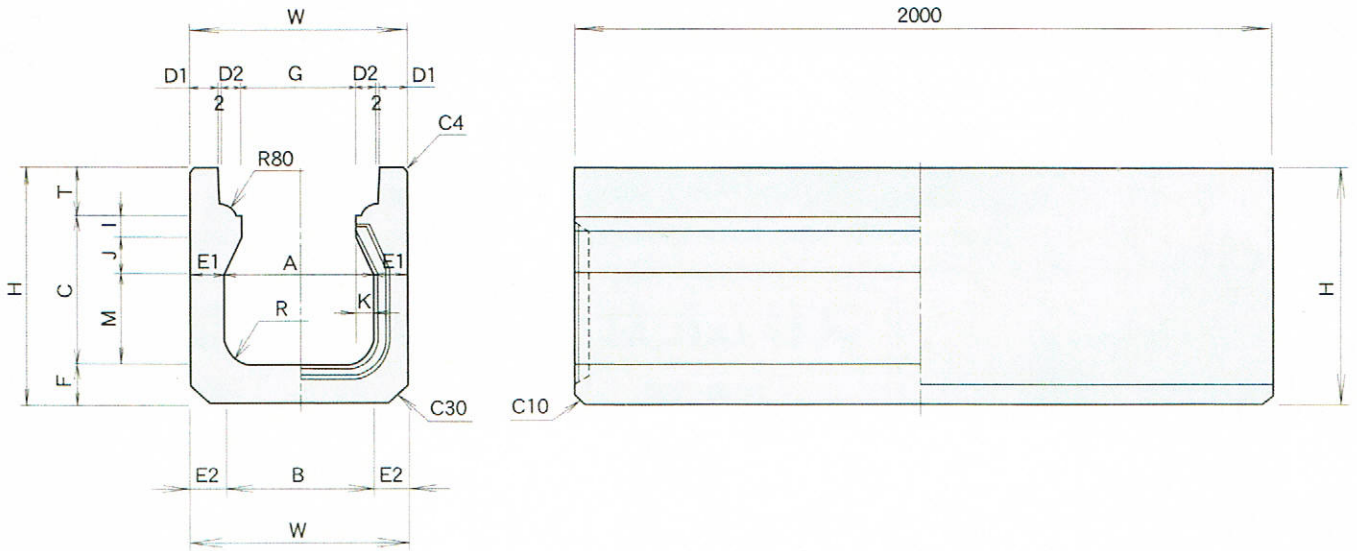

■寸法表

単位(mm)

呼び名	寸 法																	参考重量 (Kg)
	A	B	C	D1	D2	E1	E2	F	G	H	I	J	K	M	R	T	W	
240×240	240	240	238	40	36	55	55	65	194	390	30	65	28	143	40	87	350	278
300×300	300	300	298	50	36	60	60	70	244	455	30	65	28	203	50	87	420	357

■コンクリート蓋(車道用)

(単位:mm)

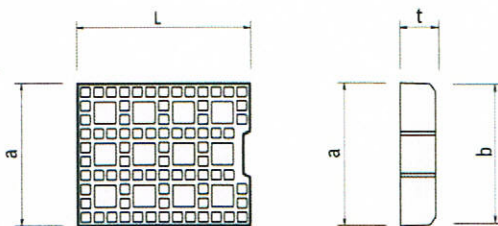

呼び名	寸 法				参考重量 (Kg)
	A	b	t	L	
240	262	255	85	498	25
300	320	315	85	499	31

■グレーチング

(単位:mm)

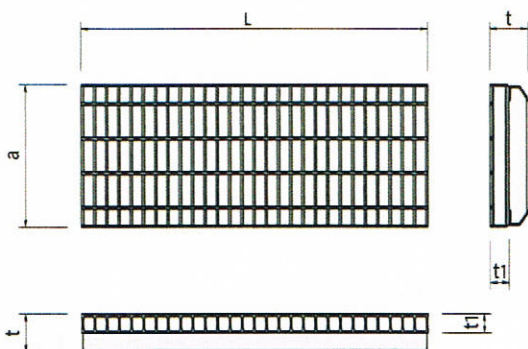

呼び名	寸 法				参考重量 (Kg)
	a	t	t1	L	
240	260	81	38	995	19
300	320	85	44	995	23

FX防音可変側溝 車道用 蓋

車道用 (T-25)

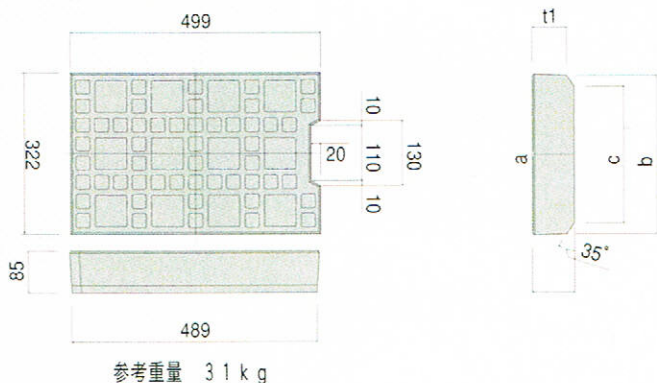

スリット蓋タイプ

平面図

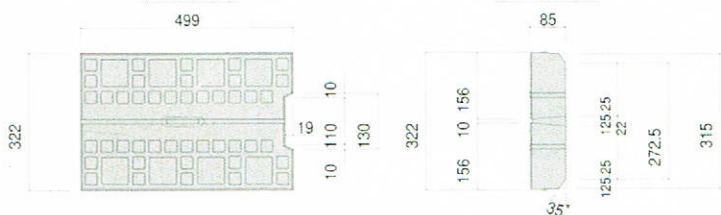

T-25対応 (50kN)

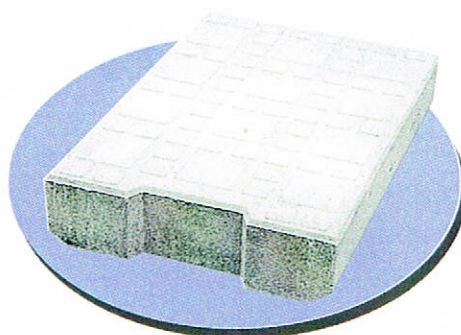

■規格表

呼び名 (幅×深)	寸法 (mm)					参考重量 (kg)
	a	b	c	t	t ₁	
300	322	315	272.5	85	—	31
300 スリット蓋						
400	422	413	363.2	100	—	47
500	532	523	466	115	—	69
600	642	633	576	130	—	96

FX防音可変側溝 歩道用 蓋

歩道用

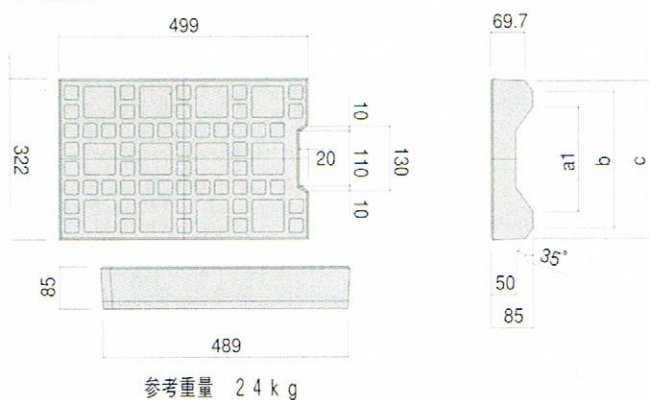

スリット蓋タイプ

平面図

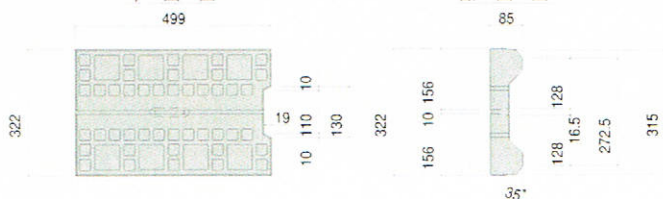

T-2対応

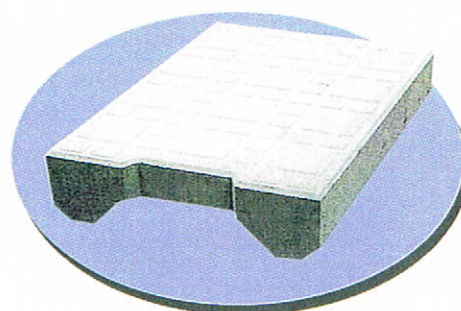

■規格表

呼び名 (幅×深)	寸法 (mm)					参考重量 (kg)
	a	b	c	t	t ₁	
300	322	315	272.5	85	50	24
300 スリット蓋						
400	422	413	363.2	100	55	34
500	532	523	466	115	65	49
600	642	633	576	130	75	67
700	752	744	655	140	85	137
800	852	844	755	150	90	163
900	952	944	855	160	95	192
1000	1052	1044	955	170	100	222

FX防音可変側溝

車道用T-25対応

歩道用T-2対応

横断用ボルト固定式T-25

グレーチング

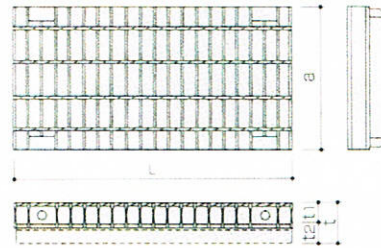
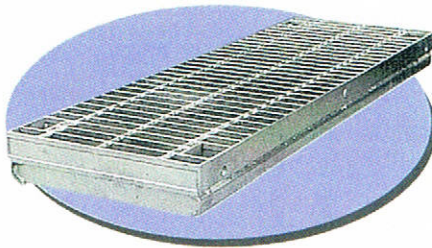
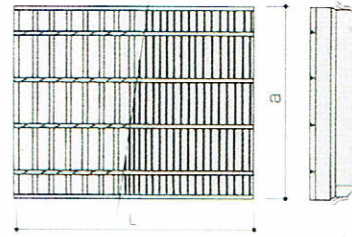
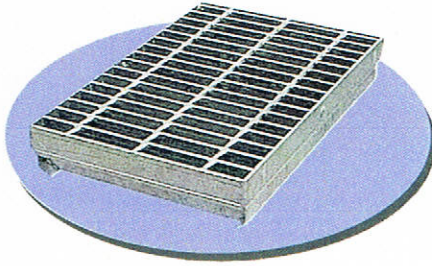

■固定部詳細

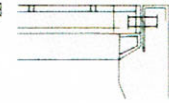

グレーチング

	呼び名		規格	参考重量(kg)
300	車道用 (T-25)	300-0.5用	320×495×85/44	10
	車道用 (T-25)	300-1.0用	320×995×85/44	20
	歩道用 (T-2)	300-0.5用	320×495×85/25	8
	歩道用 (T-2)	300-1.0用	320×995×85/25	16
	横断用 (T-25) ボルト固定式	300-1.0用	320×995×85/44	22
400	車道用 (T-25)	400-0.5用	420×495×99/55	17
	車道用 (T-25)	400-1.0用	420×995×99/55	35
	歩道用 (T-2)	400-0.5用	420×495×99/25	12
	歩道用 (T-2)	400-1.0用	420×995×99/25	25
	横断用 (T-25) ボルト固定式	400-1.0用	420×995×99/65	42
500	車道用 (T-25)	500-0.5用	530×495×115/75	29
	車道用 (T-25)	500-1.0用	530×995×115/75	58
	歩道用 (T-2)	500-0.5用	530×495×115/32	15
	歩道用 (T-2)	500-1.0用	530×995×115/32	30
	横断用 (T-25) ボルト固定式	500-1.0用	530×995×115/75	60
600	車道用 (T-25)	600-0.5用	640×495×130/90	47.7
	車道用 (T-25)	600-1.0用	640×995×130/90	95
	歩道用 (T-2)	600-0.5用	640×495×130/32	18
	歩道用 (T-2)	600-1.0用	640×995×130/32	36
	横断用 (T-25) ボルト固定式	600-1.0用	640×995×130/90	97.5
700	車道用 (T-25)	700用×800	750×800×140/100	66
	歩道用 (T-2)	700用×800	750×800×140/38	35
	横断用 (T-25) ボルト固定式	700用×800	750×800×140/100	64.5
800	車道用 (T-25)	800用×800	850×800×150/100	86
	歩道用 (T-2)	800用×800	850×800×150/38	39
	横断用 (T-25) ボルト固定式	800用×800	850×800×150/100	72.5
900	車道用 (T-25)	900用×800	950×800×160/125	96.2
	歩道用 (T-2)	900用×800	950×800×160/44	47.5
	横断用 (T-25) ボルト固定式	900用×800	950×800×160/125	95.7
1000	車道用 (T-25)	1000用×800	1050×800×170/125	108.5
	歩道用 (T-2)	1000用×800	1050×800×170/50	65
	横断用 (T-25) ボルト固定式	1000用×800	1050×800×170/125	105.5

FX300型用・浸透基礎板

配筋

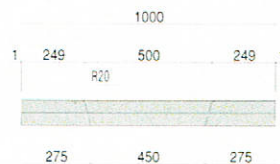
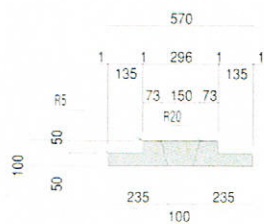
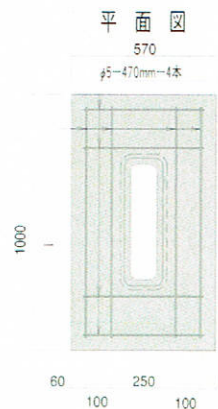

呼び名	規格	参考重量 (kg)
浸透基礎板30型	570× ⁵⁰ / ₁₀₀ ×1000	89

施工実績

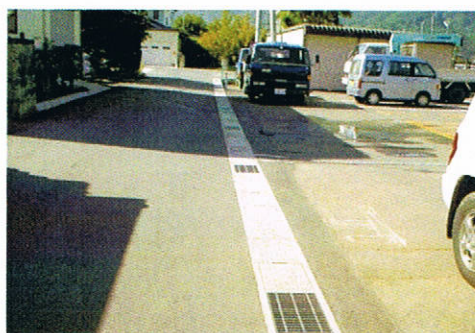

日本工業規格認証取得工場



松六コンクリート工業株式会社

長野工場 〒381-2346 長野市信更町安庭368-2
TEL(026)290-3331(代) FAX(026)299-2322
本 社 〒381-2405 長野市信州新町新町963-4
TEL(026)262-2307(代) FAX(026)262-2318

マツロクホームページ <http://www.maz6.net/>